



Flygt F-pump series

SELF-CLEANING CHOPPER PUMPS WITH SUSTAINED HIGH EFFICIENCY

FLYGT
a xylem brand

Flygt chopper pumps cut sump problems down to size



Broad range capacity

- Ratings from 1.7 to 47 kW
- Flow up to 200 l/s
- Heads up to 81 m

Rough and rugged, Flygt F-pumps tackle the toughest wastewater challenges. By cutting solids or fibers down to size, Flygt chopper pumps ensure reliable, trouble-free operation that's energy efficient, too.

Buy a ready-to-use Flygt F-pump or upgrade your Flygt N-pump for outstanding performance in heavy-duty wastewater applications.

Well proven performance

Flygt F-pumps demonstrate unmatched reliability in installations worldwide. These chopper pumps perform like no other, handling whatever goes down the drain - from plastic bottles and wood to clothing and motor cables.

Cost-effective operation

Flygt F-pumps transport tough solids and reduce operation and maintenance costs, too. Under extreme conditions, our energy-efficient chopper pumps run continuously with sustained hydraulic efficiency in heavy-duty applications such as:

- Heavy-duty wastewater applications
- Food processing facilities
- Pulp and paper mills
- Heavy-duty sludge pumping
- Aqua culture
- Agricultural facilities
- Correctional facilities
- Public access facilities



The F-pump advantage

- Cuts tough solids
- Patented N-technology
- Innovative design
- Sustained high efficiency
- Self-cleaning ability
- Fewer unplanned service calls
- Factory-tested for high performance

Chop it up with the proven N-impeller

Advanced N-technology

Flygt F-pumps feature patented Flygt N-technology, which is renowned for its self-cleaning capabilities and sustained high efficiency.

Virtually maintenance free

Flygt F-pumps feature the patented Flygt N-impeller, which rotates inside a chopper insert ring. This rotation cuts all types of hard-to-pump solids, such as fibrous material, textiles and other debris into small, easy-to-pump pieces.

Self-cleaning components

To prevent clogging, the Flygt N-impeller features a backswept design which together with the relief groove in the insert ring sweeps solid objects along the leading edge.

Sustained high efficiency

All components work together without sacrificing the pump's overall hydraulic performance. Pump efficiency consistently remains high while keeping energy costs low.

Wear-resistant material

Flygt F-pump components consist of Hard-Iron material (HRC 60), which has proven to have exceptional wear resistance in tough wastewater applications.

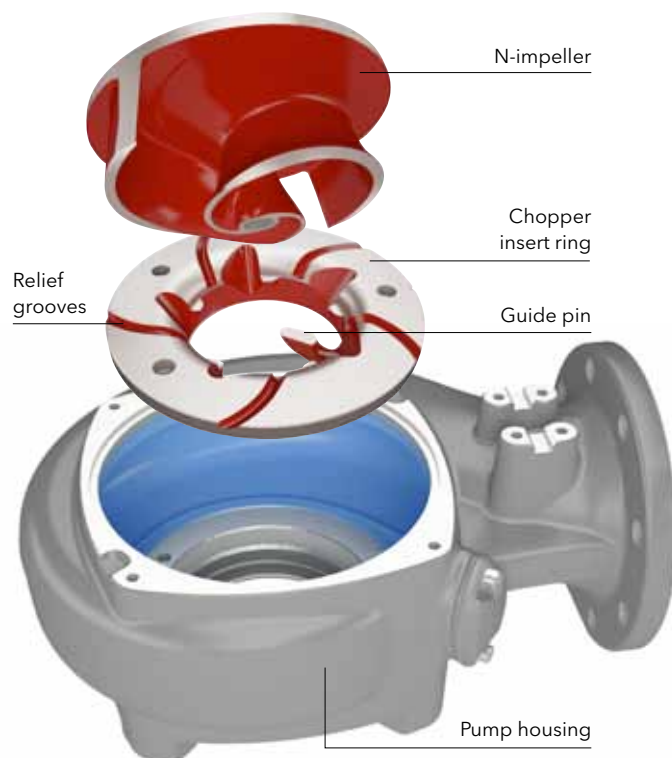

The Flygt cutting knife effortlessly chops food and fish matter, including whole fish, into small, easy-to-pump solids. Available for 3127 and 3153.



The Flygt feeding screw handles material with a high dry-solid content with ease. Available for 3153.



The Active Seal™ system, a patented zero-leakage double-seal system, actively prevents liquid from entering the motor cavity, thereby reducing the risk for bearing and stator failure.

Engineered for long life

BETTER HEAT TRANSFER

Our specially designed and manufactured motor provides enhanced cooling because heat losses are concentrated around the stator. Trickle impregnated in resin (Class H insulation), the stator windings are rated at 180°C (355°F) and enable up to 30 starts per hour.

EFFICIENT COOLING

These pumps are cooled either by the surrounding liquid or with an internal closed-loop cooling system.

INSPECTION CHAMBER

To increase operational reliability, an inspection chamber between the seal unit and the bearings enables rapid spot checks and maintenance. In the case of a seal failure, a built-in sensor provides an early warning of any fluid build-up, thus reducing the risk of expensive repair work. Standard for 3153 and above.

COMPLIANCE

Each pump is tested and approved in accordance with national and international standards, including IEC 34-1 and CSA. Pumps are available in explosion-proof versions for use in hazardous environments, and are approved by the Factory Mutual, European Standard and IEC.

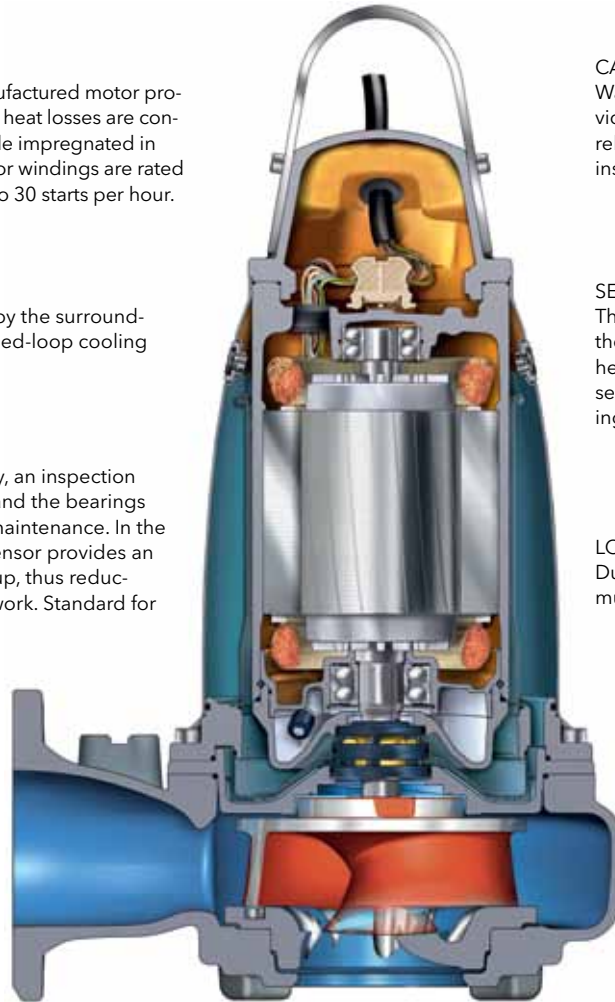

CABLE ENTRY

Water-resistant cable entry provides both sealing and strain relief functions to ensure a safe installation.

SENSORS

Thermal sensors embedded in the stator windings prevent overheating, and an optional leakage sensor minimizes the risk for bearing and stator failure.

LONG-LIFE BEARINGS

Durable bearings provide a minimum service life of 50,000 hours.

ENDURING SEALS

The Flygt Plug-in™ seal with the Active Seal™ system or Griploc™ seal offers increased sealing reliability and reduced risk of bearing and stator failure.

Methods of installation

FP

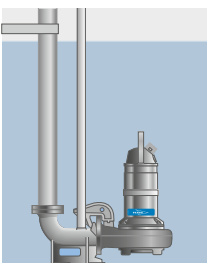

For semi-permanent wet well installations. The pump is installed with twin guide bars on a discharge connection.

FS

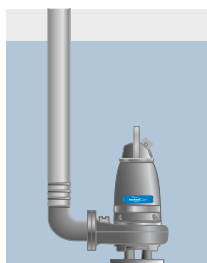

A semi-permanent free standing installation. Transportable version with pipe or hose connection.

FT

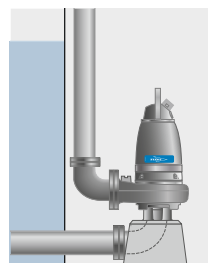

A vertically-mounted, permanent dry well or in-line installation with flange connections for suction and discharge pipe work. Available for 3127, 3153, 3171 and 3202.

FZ

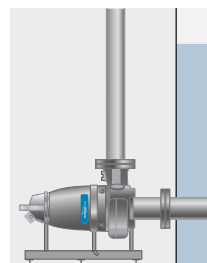

A horizontally-mounted, permanent dry well or in-line installation with flange connections for suction and discharge pipe work. Available for 3127, 3153, 3171 and 3202.

FJ

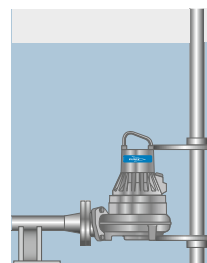

A semi-permanent installation with a swiveling guide bar for mixing and pumping. Available for 3085 and 3102.

Comprehensive range of F-pumps

The Flygt F-pump range includes seven models, that handle capacities up to 200 l/s. Designed for minimal downtime and low total cost of ownership, Flygt F-pumps provide advanced technical solutions for handling hard-to-pump solids.



Performance, 50 Hz

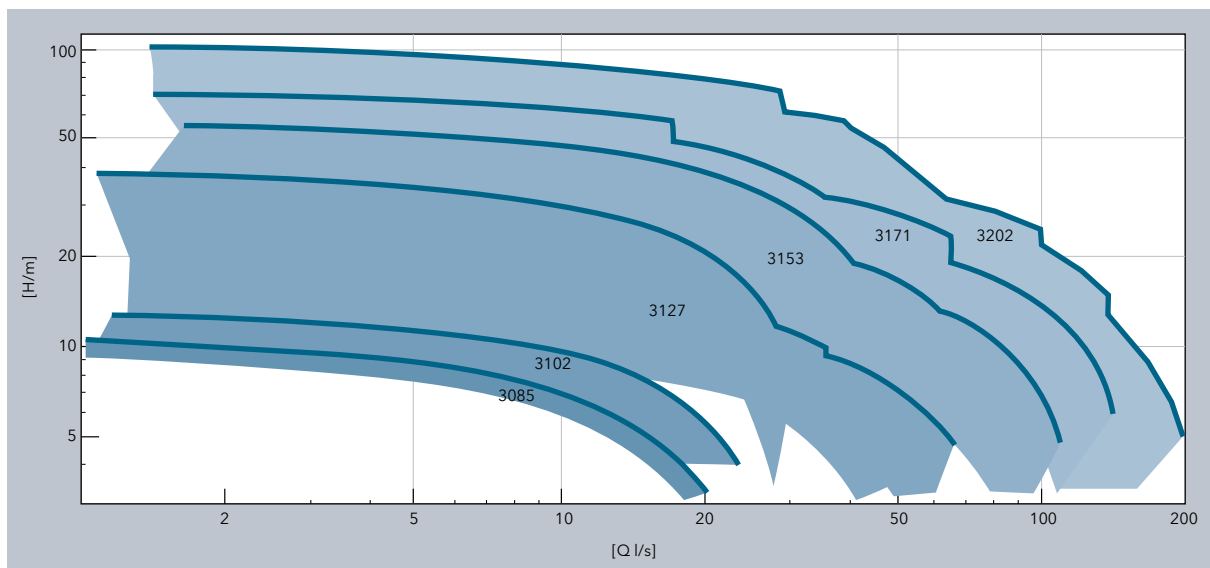

Power ratings and sizes

Model	3085	3102	3127	3153	3171	3202
Rating, kW	2.0	3.1	4.7-7.4	7.5-15	15-22	22-47
Discharge, mm (in)	100 (4")	100 (4")	80 (3") 100 (4") 150 (6")	80 (3") 100 (4") 150 (6")	100 (4") 150 (6")	100 (4") 150 (6") 200 (8")

The power to adapt

Options table

Customize your Flygt F-pump with optional equipment.

Flygt F-pump model	3085	3102	3127	3153	3171	3202
<i>Option/Product</i>						
Hydraulic						
N-impeller/Chopper insert ring			●	●	●	●
F-impeller old design	●	●				
Guidepin			●	●	●	●
Hard-Iron™			●	●	●	●
Ductile iron	●	●				
Cutting knife			◐	◐		
Feeding screw				◐		
Seal system						
Griploc™ seal	●	●	●			
Plug-in™ seal				●	●	●
Active Seal™				●	●	●
Spin-out™	●	●	●	●	●	●
Inspection chamber				●	●	●
Motor						
Insulation class	H	H	H	H	H	H
Thermal sensors	●	●	●	●	●	●
Cooling system						
1. No cooling	●	●	●	●	●	●
2. Internal				○	○	○
3. External				○	○	○
Methods of Installation						
FP	●	●	●	●	●	●
FS	●	●	●	●	●	●
FT			●	●	●	◐
FZ			●	●	●	◐
FJ	●	●				
Approvals/compliance						
Explosion proof	○	○	○	○	○	○
Accessories						
Flush valve			○	◐	◐	◐
Pump monitoring Prepared for						
- Mini CAS	●	●	●	●	●	●
- MAS				○	○	○

● = Standard

○ = Optional

◐ = Standard but also optional depending on model

◐ = Standard or not available depending on model

◐ = Optional or not available depending on model

Smart options empower operations

Flygt MiniCAS is a supervision relay for stator temperature and leakage sensors designed for Flygt F-pumps.

Flygt MAS 711 is a protective monitoring system for Flygt F 3153, 3171 and 3202 pumps.

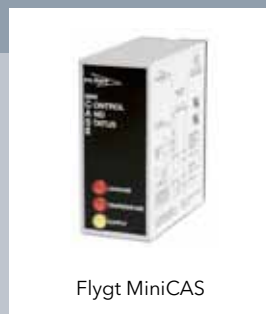

Flygt MiniCAS

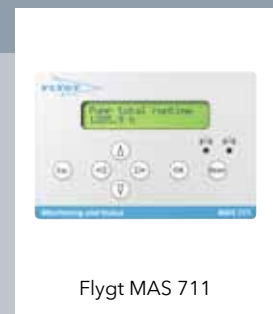

Flygt MAS 711

Supporting your business, every step of the way



Extensive monitoring and control

We supply hardware and software for complete process systems - from individual pump drives, starters, sensors and controllers to system software and scalable **SCADA** systems.



Genuine Flygt spare parts and warranty

When downtime isn't an option, rely on our global service network to deliver genuine Flygt spare parts to you - quickly and efficiently. All Flygt spare parts are backed by a solid 15-year availability guarantee.

Extensive engineering know-how

Xylem has extensive knowledge of fluid dynamics and vast practical experience in designing, operating and maintaining efficient wastewater transport systems.

We provide a broad range of engineering services, including:

- System analysis and calculations
- Sump design
- Water hammer calculations
- Pump start analysis
- Transient analysis
- Computational Fluid Dynamics (CFD)
- Scale model testing

In short, we can assist you with everything you need for optimal performance and economical, energy-efficient operation.

Empower your system

With Flygt monitoring and control products, you can control and optimize the performance of every component of your system. This helps reduce stress on pumps, valves and mains, enable reliable, efficient operation and prolong service lifetime.

Support for your Flygt pumps

Our global network of local service centers and service partners, provide integrated services to support safe, efficient and reliable operation. To ensure trouble-free operation and minimal downtime, count on us for quick, professional response and quality maintenance services, using genuine Flygt spare parts.

Xylem ['zīləm]

- 1) The tissue in plants that brings water upward from the roots
- 2) A leading global water technology company

We're 12,000 people unified in a common purpose: creating innovative solutions to meet our world's water needs. Developing new technologies that will improve the way water is used, conserved, and re-used in the future is central to our work. We move, treat, analyze, and return water to the environment, and we help people use water efficiently, in their homes, buildings, factories and farms. In more than 150 countries, we have strong, long-standing relationships with customers who know us for our powerful combination of leading product brands and applications expertise, backed by a legacy of innovation.

For more information on how Xylem can help you, go to xylem.com.



Flygt is a brand of Xylem. For the latest version of this document and more information about Flygt products visit www.flygt.com